

Data Sheet



Article number: 025848660042

Description: Norma Connect pipe coupling
COMBI GRIP GL W5 Ø42,4/40 NBR 16 bar

Measures

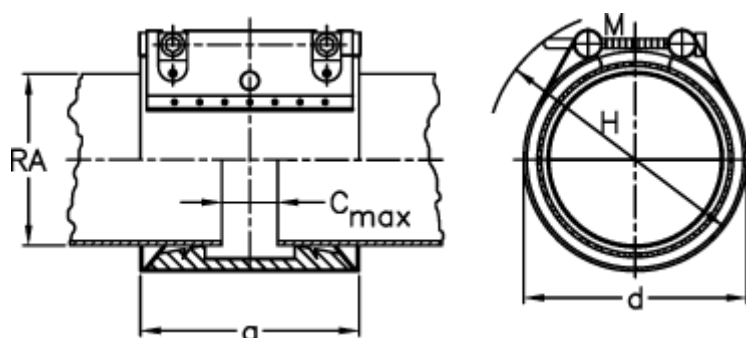

a	= 62.4	RA min-RA max plastic = 39,5-40,5
C max with insertion band	= 8	Weight a piece = 0.6
d	= 60	
H	= 80	
M (screw)	= M8	
Nominal pressure (bar)	= 16	
RA	= 42,4/40,0	
RA min-RA max metal	= 41,0-43,0	